

Stainless steel pigeonhole locker 3 column 5-tier, 15 individual compartments

Dimensions in mm

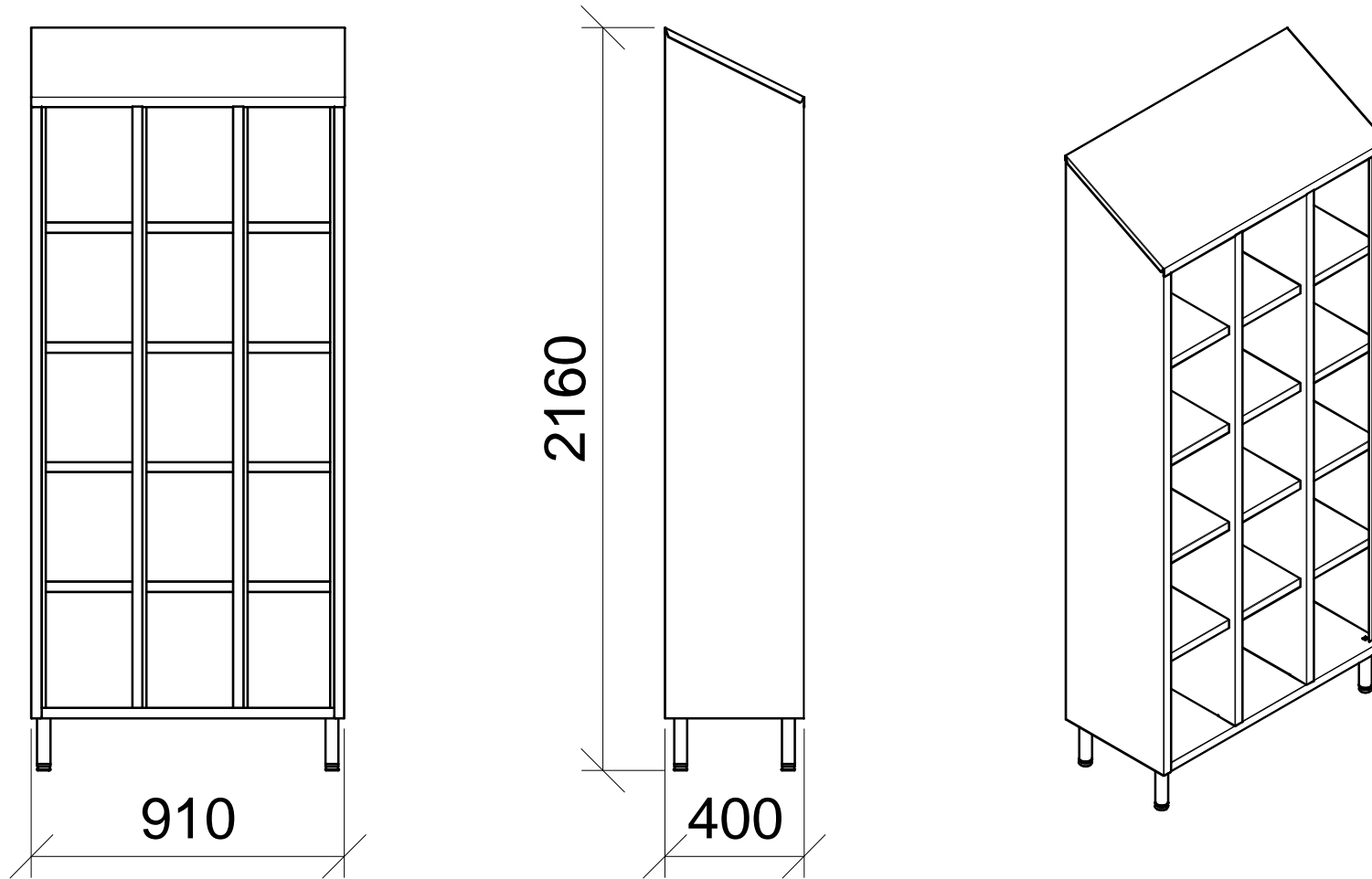

CHARACTERISTICS: 21 gauge

- 0,8 mm thick stainless steel.
- 2J finish (Scotch-Brite®).
- Dustproof slanting top.
- 3 column solution.
- 5 individual compartments per column.
- Adjustable screw on feet.

Code: X4007/15-01

FACILITAS

Via Lazio 7 A/B/C - 41050 Montale Rangone (MO)
Web: www.facilitas.it @: facilitas@facilitas.it
Tel:+39 (0)59-530570 Fax:+39 (0)59-4909000